



2017 ICC/A117.1 Update

Presenter: Kim Paarlberg

Tuesday, September 12, 2017

9:45 AM – 11:15 AM



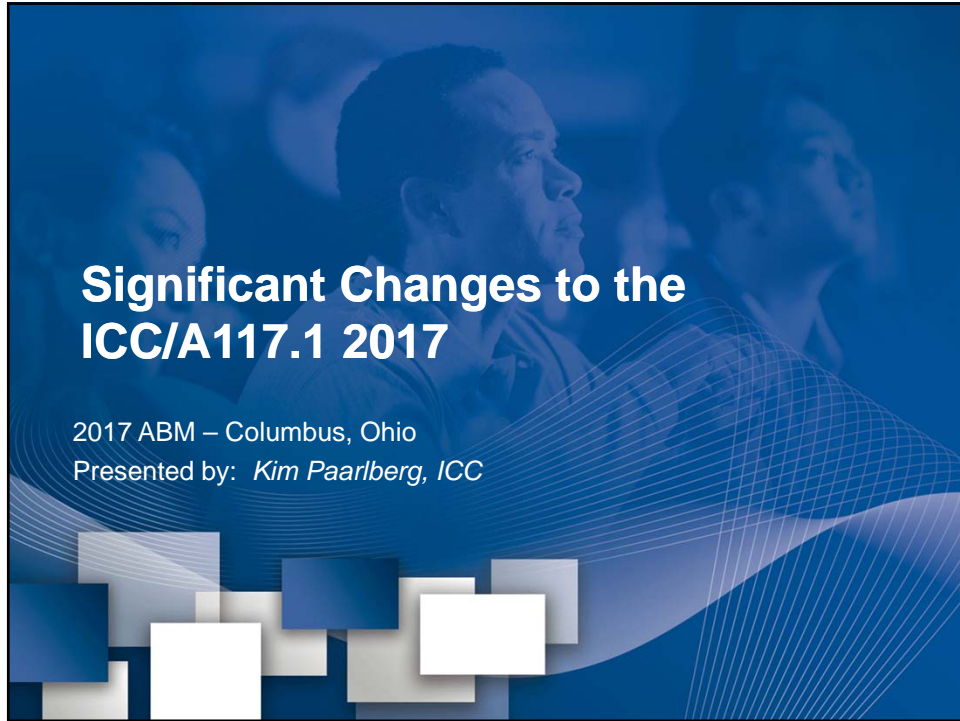

Requirements

Scoping :

- “What, Where and How Many”
- 2015 IBC and IEBC

Technical:

- “How”
- ICC/ANSI A117.1-2009



ICC A117.1 Accessible and Usable Buildings and Facilities

- Standard & Commentaries.
- History, reasoning and examples
- Technical assistance via phone, email or letter.



3

Role of the Code Official

- Enforce the locally adopted building code and any local or state laws
- Does not enforce ADA or FHA.



4

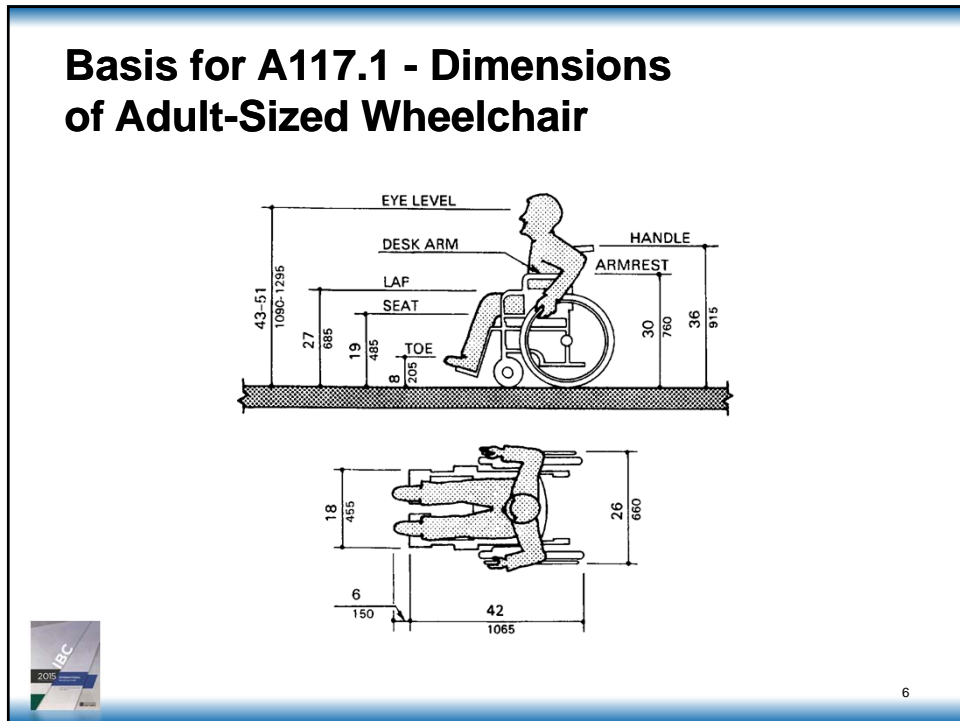

2017 ICC A117.1

- Revisions
 - Study on Anthropometry of Wheeled Mobility
 - Sponsored by the US Access Board
 - Including persons using manual wheelchairs, motorized wheelchairs & scooters
- <http://www.udeworld.com/anthropometrics.html>



7

Human Factor Anthropometrics

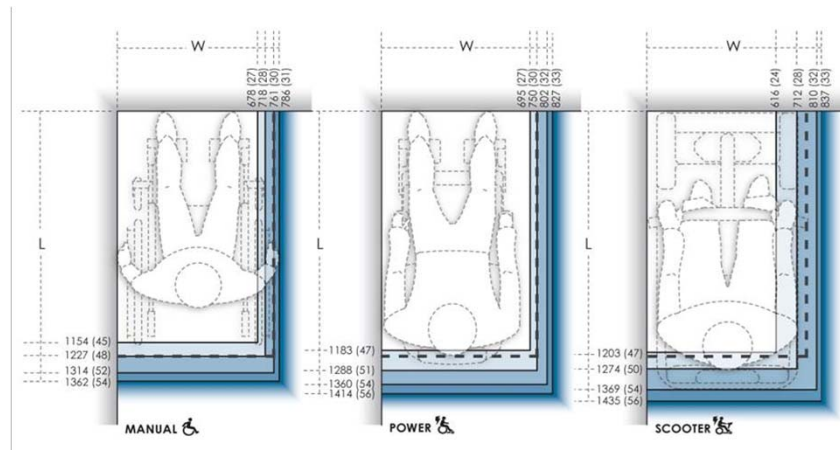

8

Existing building and facilities

- New sizes will not apply to existing buildings or facilities
- Will apply to new construction and additions
- Definition:
 - **existing building.** A building erected prior to the date of adoption of this standard, or one for which a legal building permit has been issued.



9

Building Blocks

- Clear floor space
- Turning space
- Operable parts

Wheelchair space

Existing – 48”

New – 52”

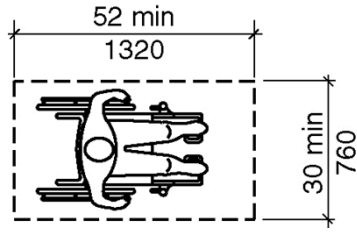
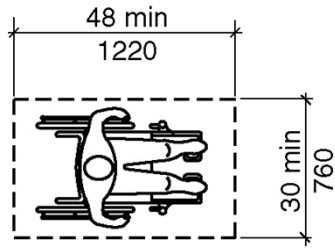

11

Turning space

Existing – 60”

New – 67”

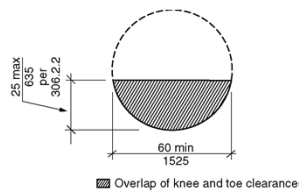

12

Turn comparison

Existing

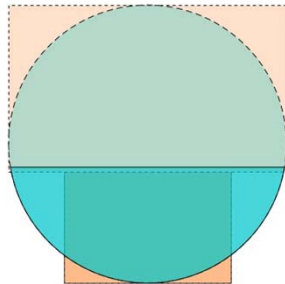

New

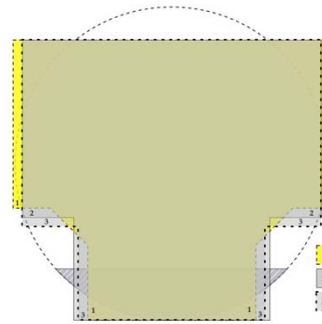

Base overlap of turns



15

Operable parts

Kitchen Outlet Exception:

- Over counter top in a corner between appliances
- Counter top area does not exceed 9 square feet maximum.

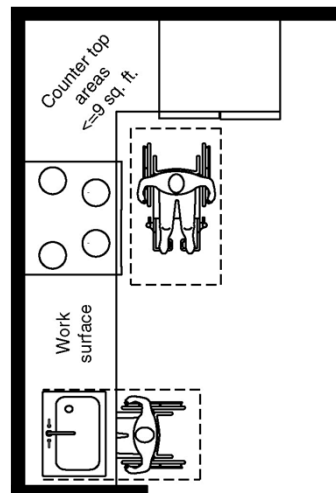

16

Accessible Routes

- 90 degree turn
- 180 degree turn
- Turning space
- Doors
- Exterior routes
- Platform lifts

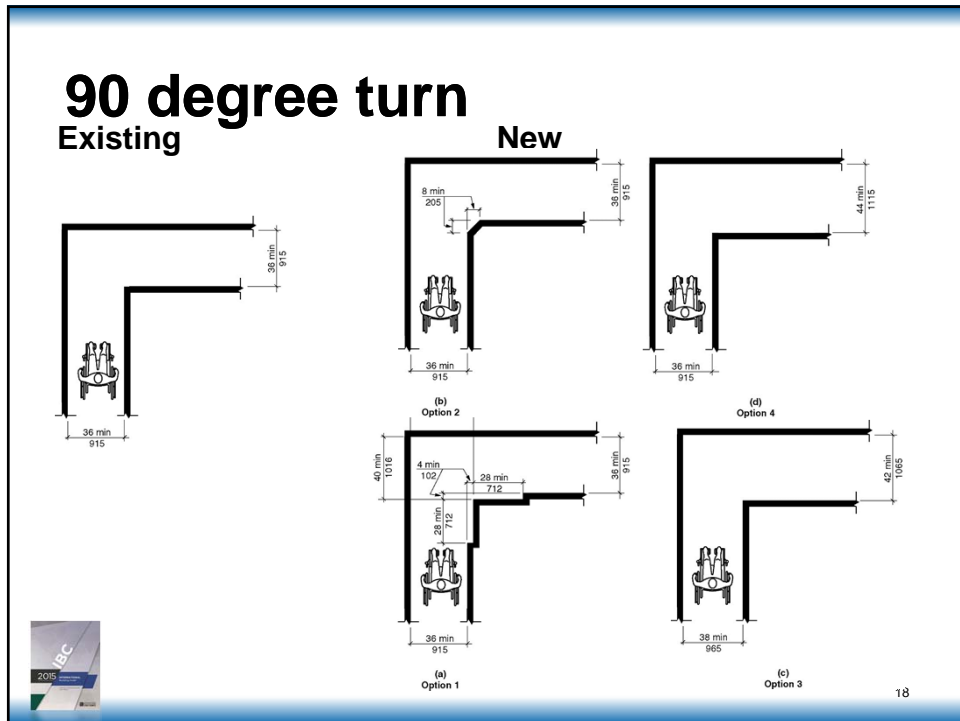

Turn around obstruction

Existing

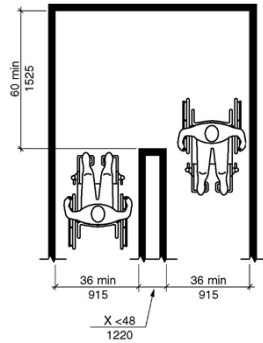

(b)
180 Degree Turn
(Exception)

New

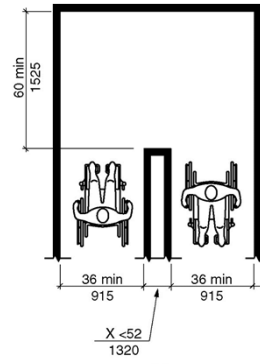

(a)
Option 1



Turn around obstruction

Existing

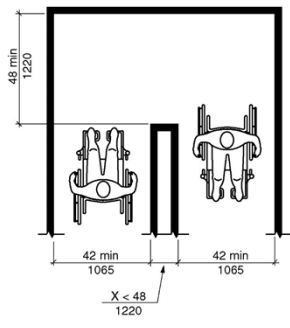

(a)
180 Degree Turn

New

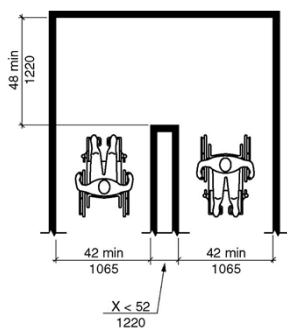

(b)
Option 2

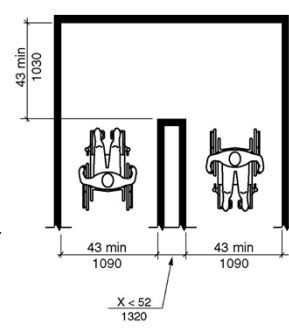

(c)
Option 3



Passing space

Existing

New

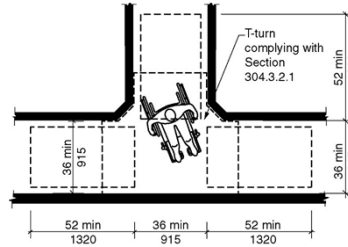
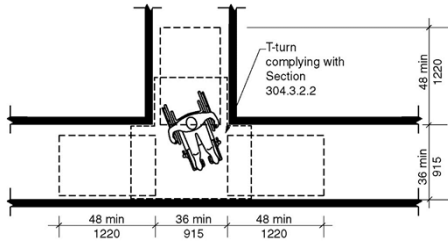

Impact - Turns in a small store

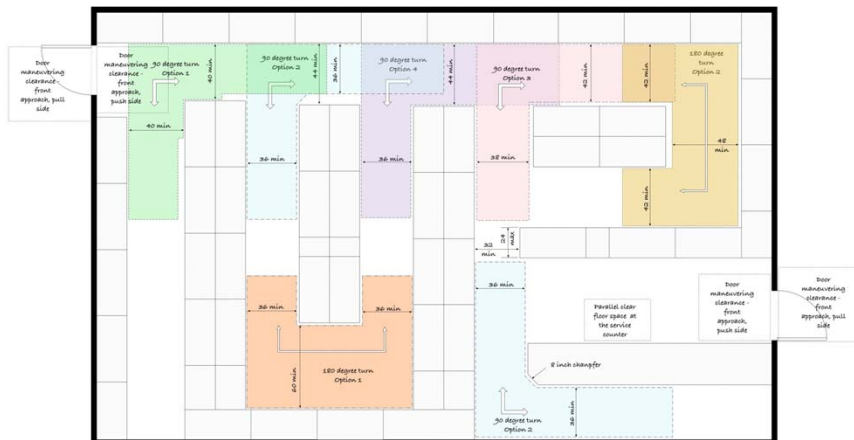

Impact - Multi-stall layout

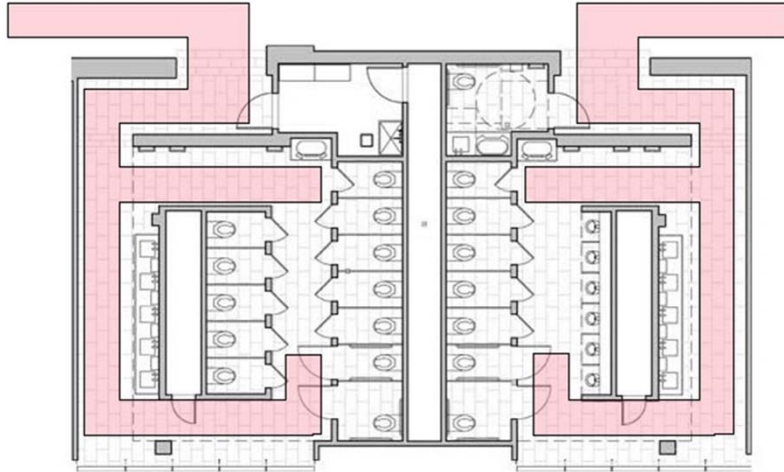

23

Impact - Dining room layout

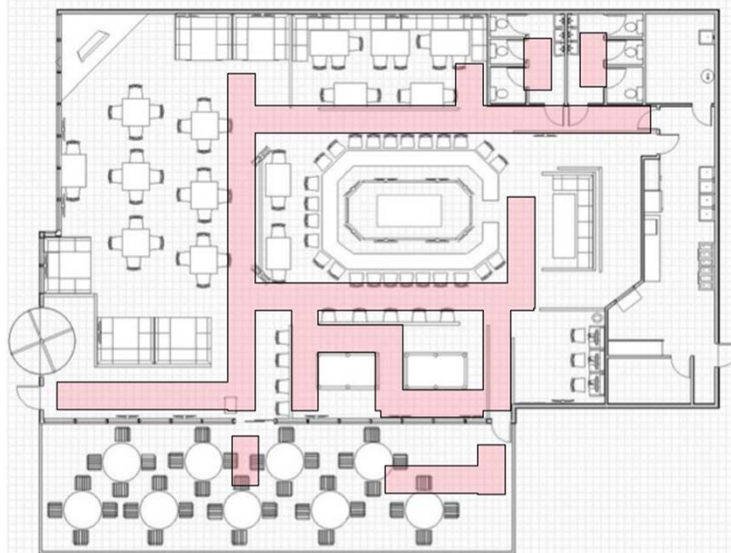

24

Doors: 404.2.3 Obstructions to the Maneuvering Clearance

- Removed from 2015 A117.1
- Prohibits the use of knee and toe clearances (i.e., under sinks or counters) when overlapping maneuvering space at a door.
- The intent is that users do not need to reach over an obstruction to operate the hardware.

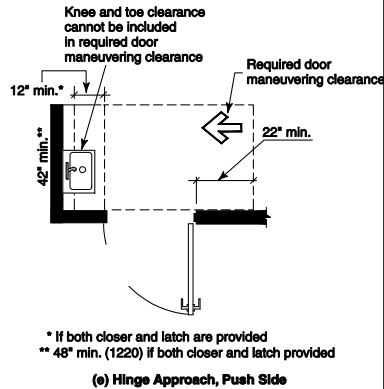

25

Door maneuvering size

Existing – 48"

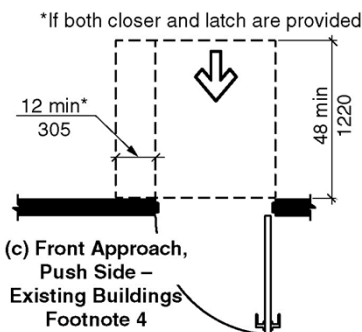

New – 52"

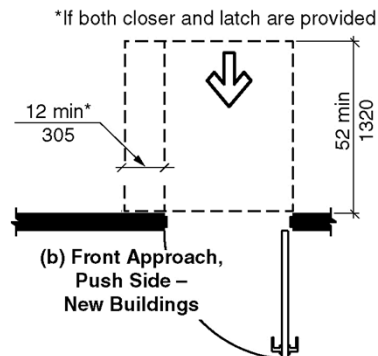

26

Vestibules

Existing

New

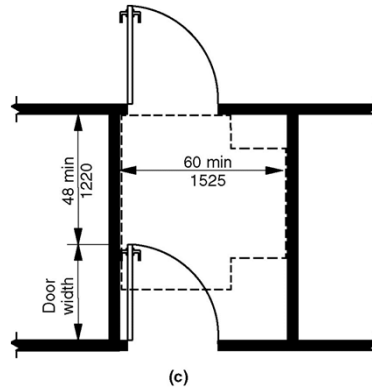
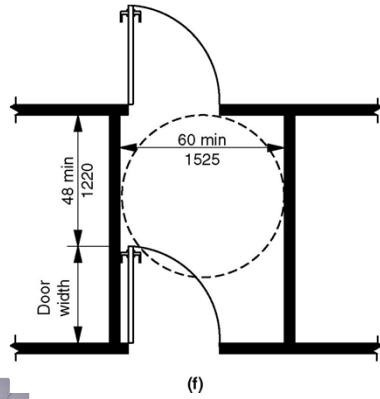

27

Exterior route

Existing

New

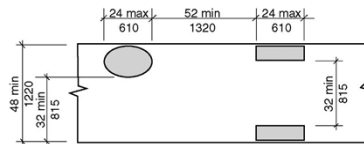
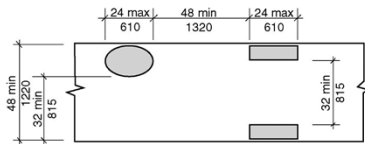

28

Curb Ramps

Perpendicular

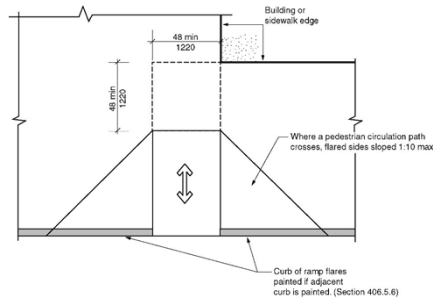

Parallel

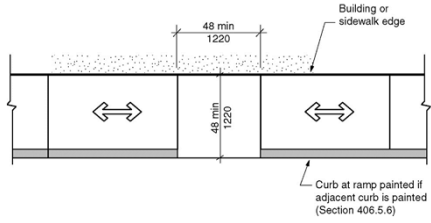

Blended Transitions

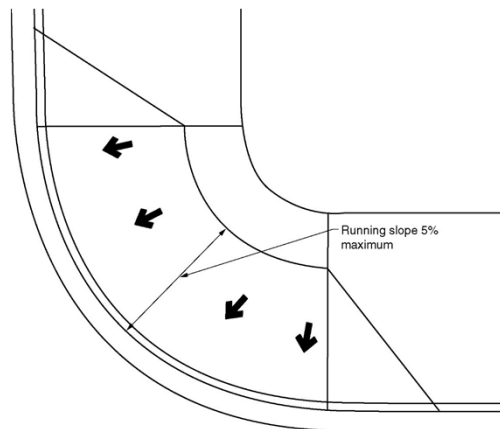

Platform Lifts

- Change in size for vertical platform lift for new clear floor space size – 36” x 52”
- Incline platform lift with barriers permitted to use 36” x 48”

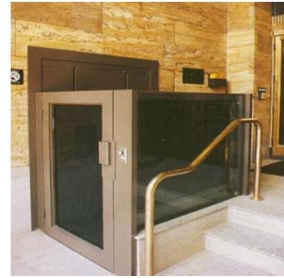

31

General Site and Building Elements

- Parking
- Meters
- Electrical Charging Stations
- Route across parking lot
- Windows

Angled street parking

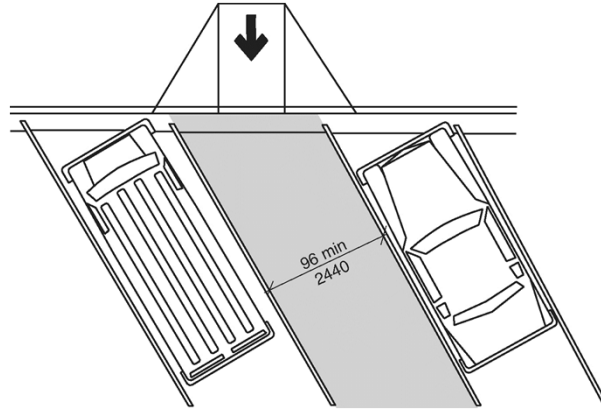

33

Parallel street parking

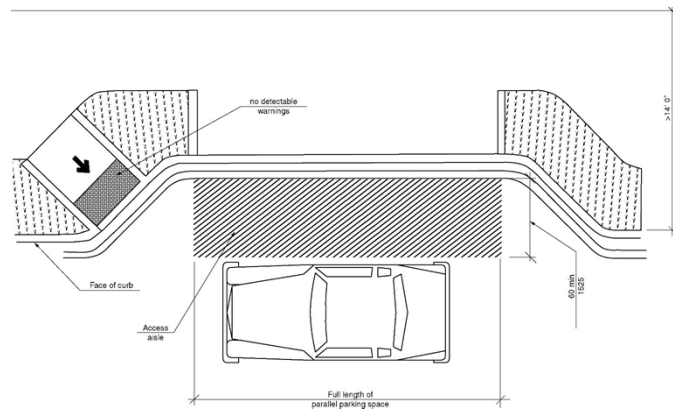

34

Parking meters and pay stations

- Clear floor space
- Reach range
- Operable parts
- Displays



35

Electric vehicle charging stations

- Clear floor space
- Reach ranges
- Operable parts
- Route not obstructed by cord or barriers



36

Routes across parking lots

- Protected accessible route across parking lots

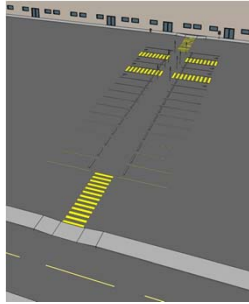

37

Windows

- One window per room except kitchens and bathrooms
 - emergency escape and rescue
 - natural ventilation
- Four forces on a window – locking, unlocking, opening and closing
- Locking/unlocking are operable parts
- Opening/closing - AAMA 513

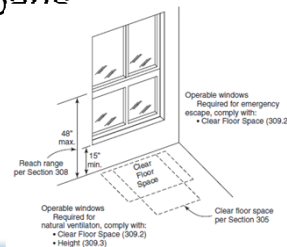



Stall options

- End or row stall or new alternative stall

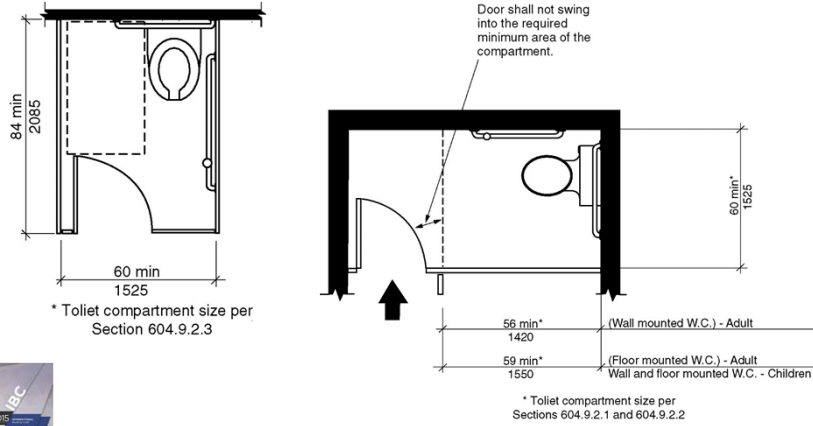

41

Partition

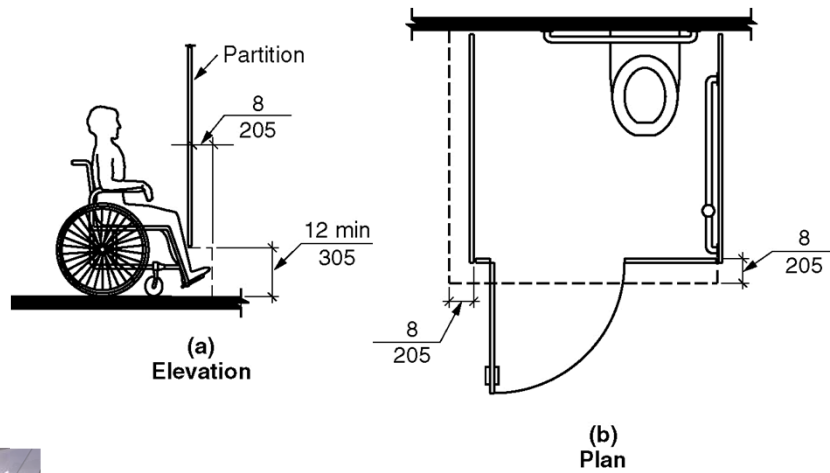

42



Visual relay service booth

- Seating
- Privacy enclosure
- Two-way video communication system
- Background

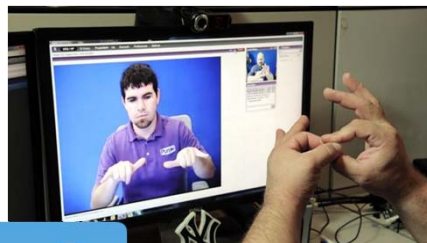

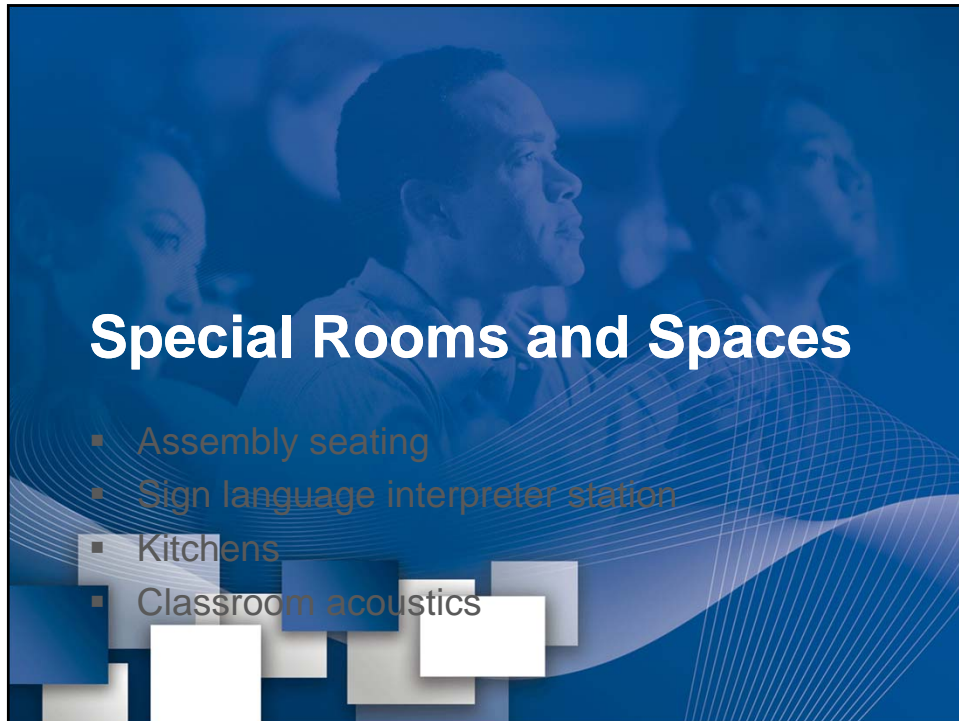

Special Rooms and Spaces

- Assembly seating
- Sign language interpreter station
- Kitchens
- Classroom acoustics

Assembly Areas: Definitions



- **wheelchair space:** A space for a single wheelchair and its occupant.
- **wheelchair space locations:** A space for a minimum of a single wheelchair and the associated companion seating. Wheelchair space locations can contain multiple wheelchair spaces and associated companion seating.



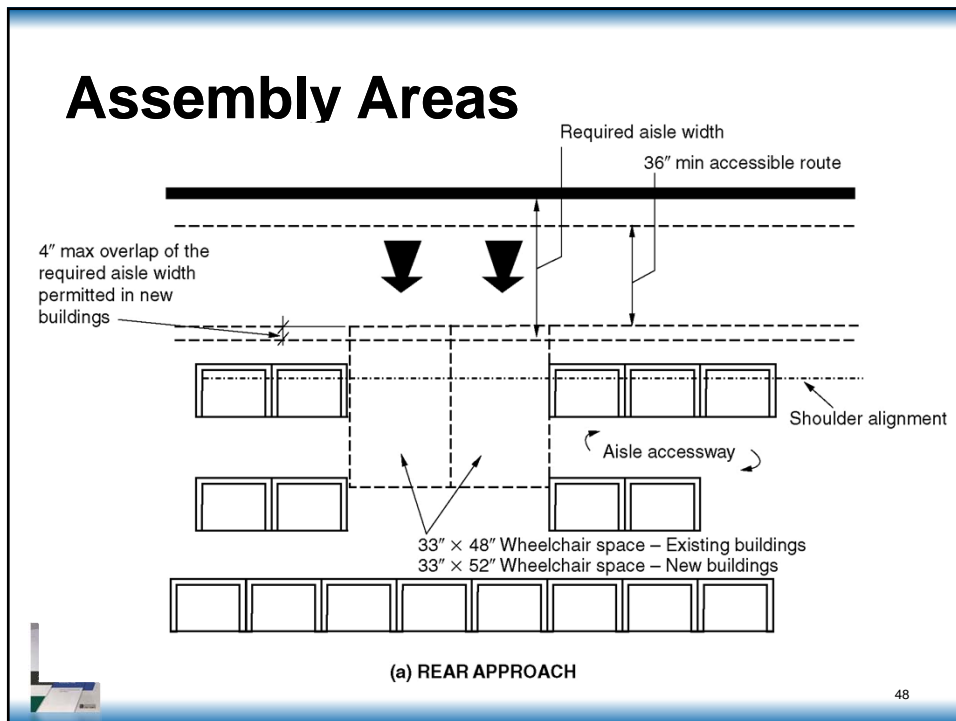
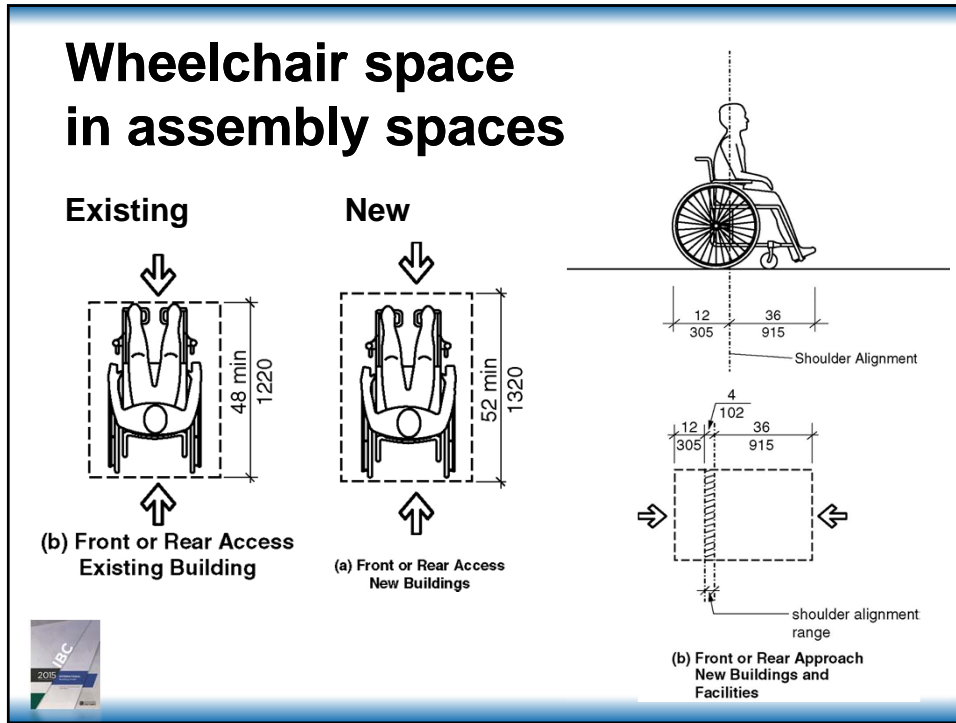

Dinner Theaters & Lecture Halls



- Dispersion based on assembly seating to view an event
- Not work surface or dining room dispersion throughout



49

Sign language interpreters stations

- Area to stand
- Viewing angle for audience
- Illumination
- Backdrop

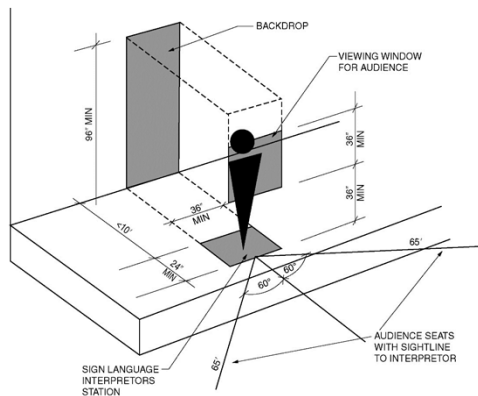

50

Kitchen Island

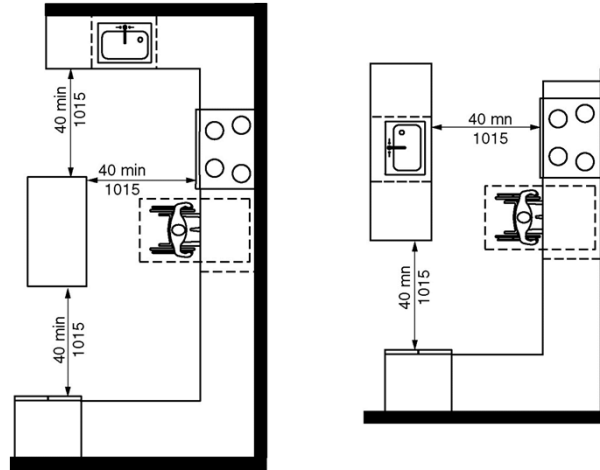

51

Kitchenettes

- Requires 40 inch minimum clearance between cabinets, appliance and any walls at kitchenettes.
- Pass thru not required for kitchenette.
- Work surface not required in kitchenette.
- Parallel approach at sink.
- Turning space where within an Accessible or Type A unit.

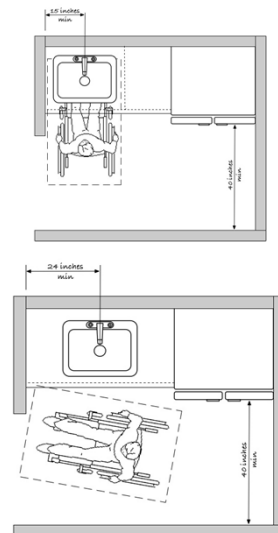

52

Classroom acoustics

Classrooms <20,000 cubic feet

Classroom Acoustics Requirements

Learning Space	Greatest one hour average sound level of exterior source background noise	Greatest one hour average sound level of interior source background noise	Maximum reverberation times for sound pressure levels in octave bands with frequencies of 500, 1000 and 2000 Hz.
Classrooms with an enclosed volume of <= 10,000 cubic feet	35 dBA/55 dBC	35 dBA/55 dBC	0.6 seconds
Classrooms with an enclosed volume of > 10,000 cubic feet and <= 20,000 cubic feet	35 dBA/55 dBC	35 dBA/55 dBC	0.7 seconds



53

Furnishings and Equipment

- Service windows
- Gaming machines and tables

Service window

- Applicable to public side (not employee side)
- Side or front approach
- Equal customer counter
- Maximum barrier height to allow for face-to-face contact between employee and customer
- Allowance for security windows

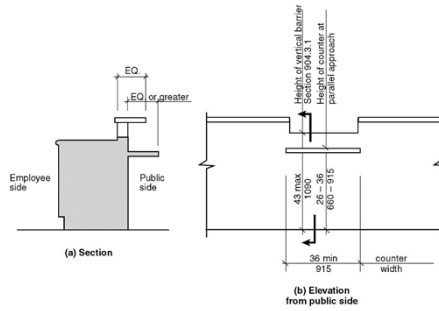
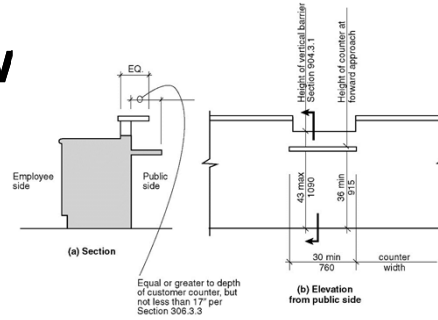

55

Service windows



56

Gaming machines and tables

- Clear floor space next to gaming table or machine



57

Recreational Facilities

- Shooting facilities

Elevated Shooting Platform

- Exception:
 - 500 sq.ft. maximum
 - Elevated over 12 feet



59

Dwelling Units and Sleeping Units

- Accessible units
- Type B units

Charging stations; Mattress height

- Charging Station:
 - Charge a motorized wheelchair
 - Option at assembly wheelchair space
 - Same space as transfer space next to bed in Accessible hotel or dorm rooms
- Mattress height



61

Type B units

- Keep old size
- Match FHA

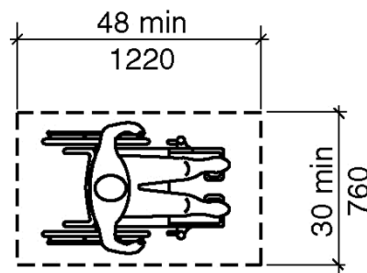

62



International Codes – Code Change Process Logistics

- I-Code published every 3 years.
- 15 codes split into two groups: A, B.
- Single cycle for each group
 - Code Development
 - Final Action Hearings
- Repeat
- 2018 available in fall of 2017.



64

A117.1 Standard: Change Process Logistics

- 5 year development cycle.
- One cycle of development between editions
 - Years 1 and 2: study groups
 - Years 3, 4 and 5: processing changes and publication.
- Repeat
- 2017 A117.1 available in fall of 2017

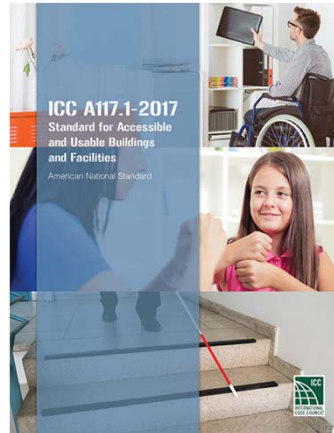

65

Questions?



66